



Blue Carbon  
蓝晶易碳

# PV ENERGY STORAGE SYSTEM

## 10kWh Stackable Floor Type Power Can

BCT-V-48-200

LiFePO<sub>4</sub> Battery Pack



Blue Carbon, no need electricity bill at all.

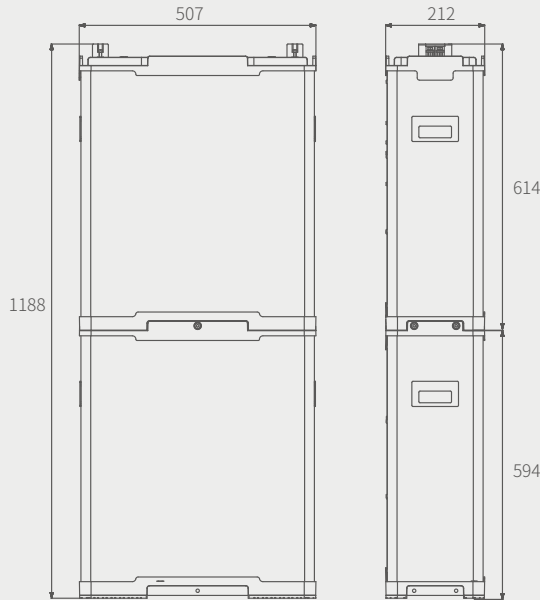
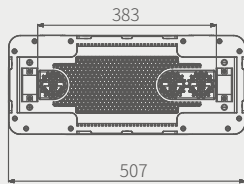

### Basic Specifications

Nominal Capacity	200Ah
Nominal Voltage	48V(51.2V)
Electricity(kWh)	10.24kWh

### Input

Full charge Voltage	56V-60V
Maximum Charging Voltage	90V
Input Voltage Range	60V-100V
Continuously Use Input Current	100A
Maximum Solar Panel Input Current	100A
Rshoot Delay Protection	1000ms

### Output

Continuously Use Output Current	100A
Discharge Cut-off Voltage	38V-48V
Over-Discharge Delay Protection	1000ms
Short Circuit Protection Delay	300us
Short Circuit Protection Recovery	Disconnect load
Instant Start Current	300A
Instant Start Current Time	10S

### Battery

Cell type	LiFePO4 Battery/LFP
Storage temperature range	Short-Term -20°C-40°C(Within 1 month) Long-term 10°C-35°C(Within 1 year)
Operating temperature range	-15°C-60°C
Recommended temperature range	10°C-40°C
Storage humidity	≤75% RH
Atmospheric pressure	Below 5000 above sea level
Self-Discharge ( 25°)	<3%/Month
Depth of discharge	>80%
C-rate Discharge	<0.8C
Cycle life	>6000Time(<0.5C)

### Other

Certification standards	UN38.3/CE/MSDS/DGM
Warranty	5 years
Product Size	614±2×507±2×212±2mm
Packing Size	668±2×645±2×713±2mm

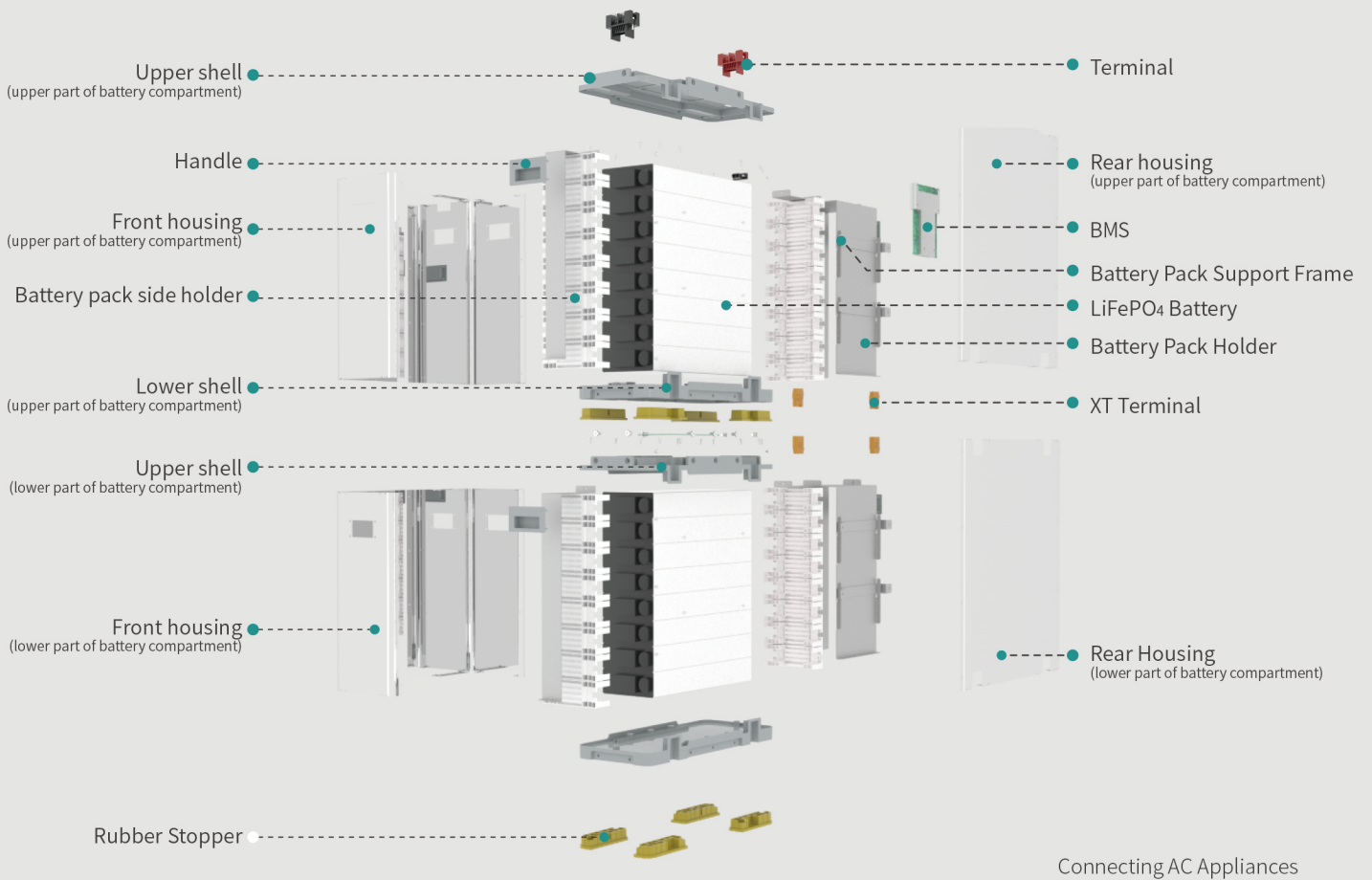

Store your electric energy to cope with the evening peak or power outage.



More Available Power



Flexible Investment



Simple Installation



Safe & Reliable

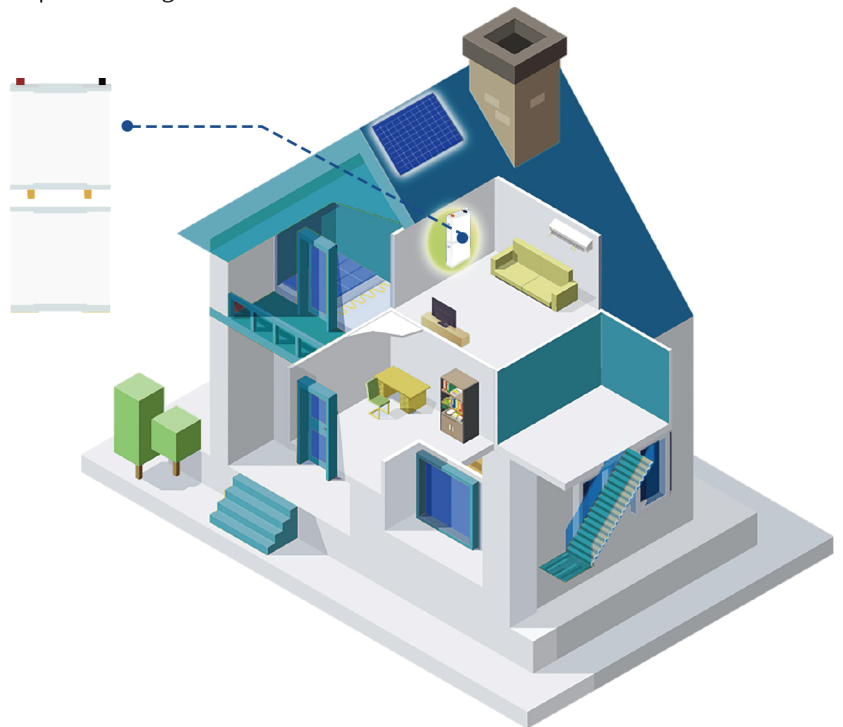

matters need attention:

- It is strictly forbidden to install near bedroom and nearby flammable material.
- Installation in inhabited rooms is not recommended.
- It is strictly forbidden to use the controllers, inverters, inverters and controller integrated equipment which are not professionally matched.

### BCT

### PRODUCT ADVANTAGES

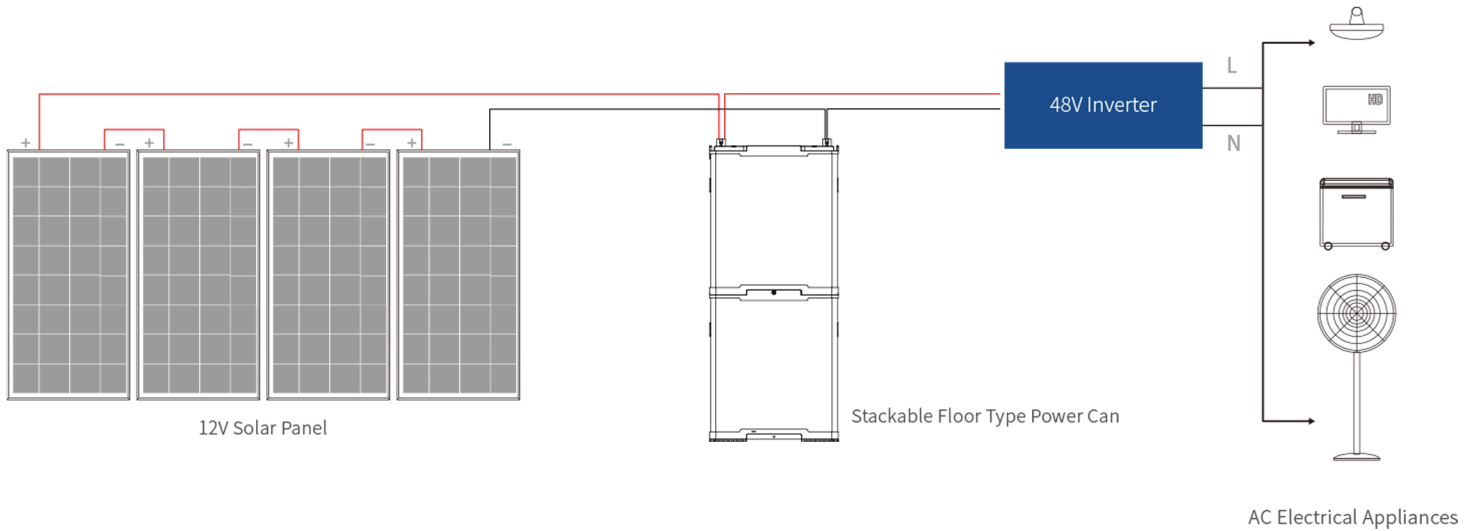

- All in one mould design and production, easy to install.
- With longer span life LiFePO4 battery, over 12 years lifespan, ensure the whole set products' life span.
- Dustproof structure design, DC output, safe and reliable.
- Integrated packaging, safe and convenient to transport.
- Wide voltage input, when unexpected high voltage input, can effectively block the high voltage, so that the BMS of the battery will not be broken down, greatly reducing the risk of thermal runaway combustion of lithium battery.
- Compact appearance design, extremely compressed product thickness, greatly reducing space occupancy.
- High quality aluminium magnesium alloy, anti-corrosion, substantial, durable, artistic, practical.
- Integrated charging and storage, reduce wiring, installation and other work, and facilitate user operation.

#### Military aviation plug

Never oxidize in high temperature, high humidity and high-salt environment; No risk of thermal runaway and fire



#### Split-type building block design

Buckle design, which can increase the capacity by alignment and stacking; Firmly fixed and can be carried by single person



#### Rubber Feet Pad

The bottom of battery is equipped with rubber feet pad to increase safety and play roles of shock-proof buffer, anti-static, electrical insulation and so on.

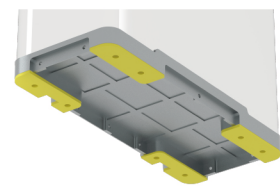



# BCT

## Battery Specification

Different Rate Discharge Curve (25°C)

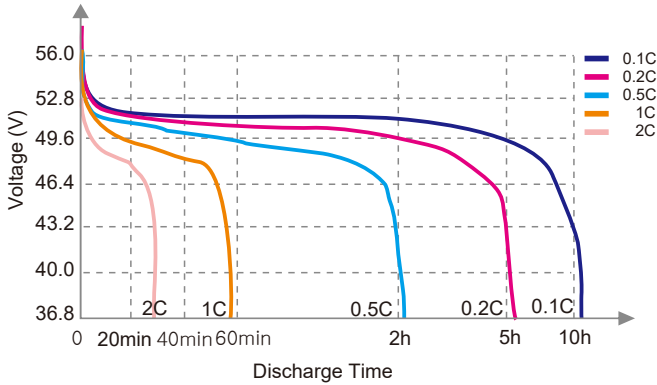

Different Temperature Discharge Curve (0.5C)

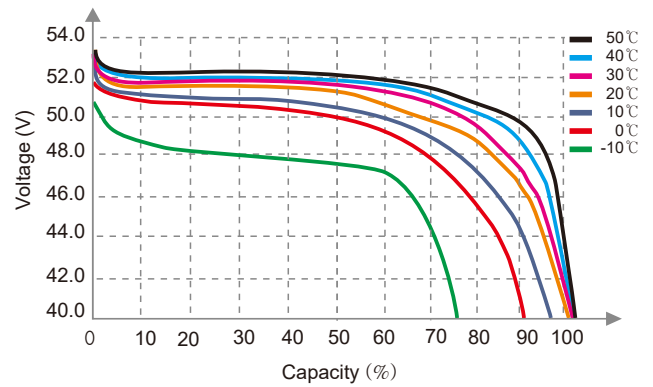

State of Charge Curve (0.5C, 25°C)

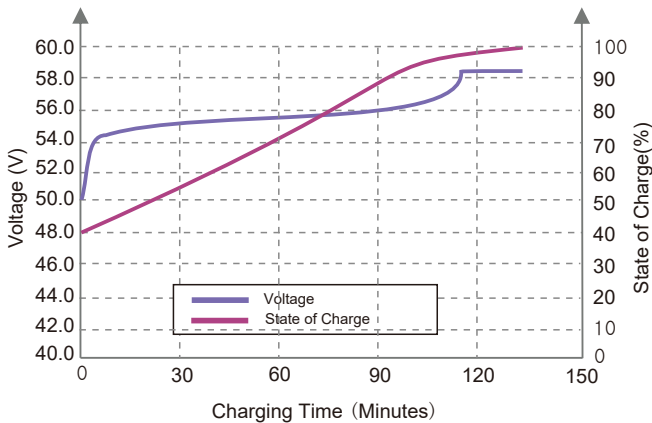

Charging Characteristics (0.5C, 25°C)

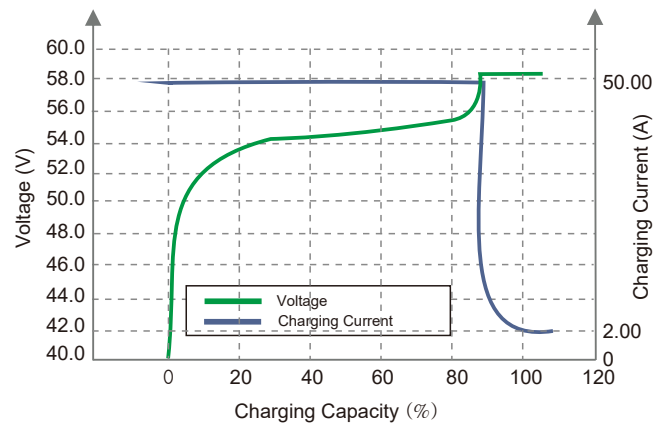

Different DOD Discharge Cycle Life Curve (1C)

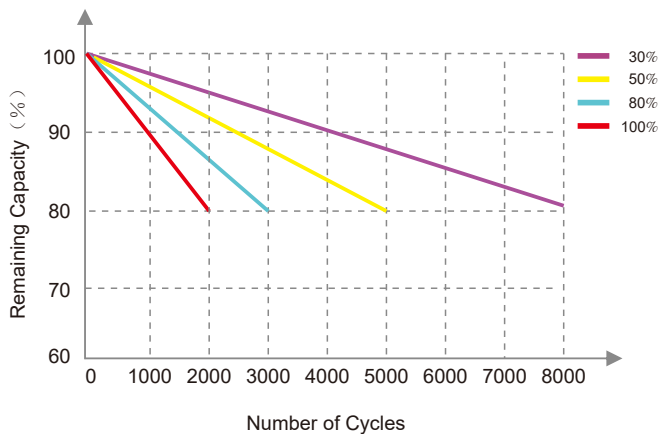

Different Temperature Self Discharge Curve

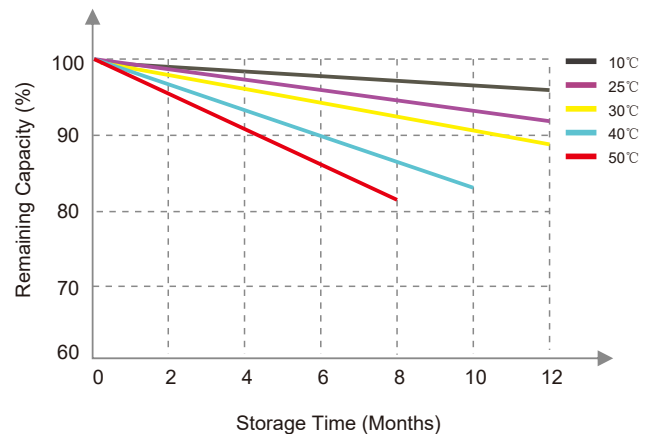



Blue Carbon  
蓝晶易碳

BCT

SCENES TO BE USED

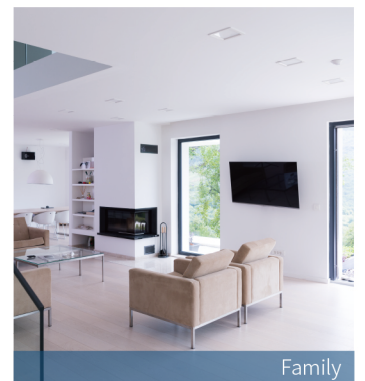
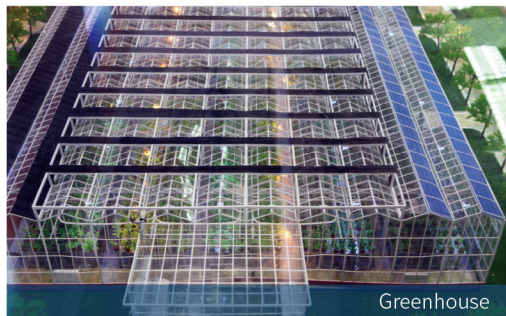
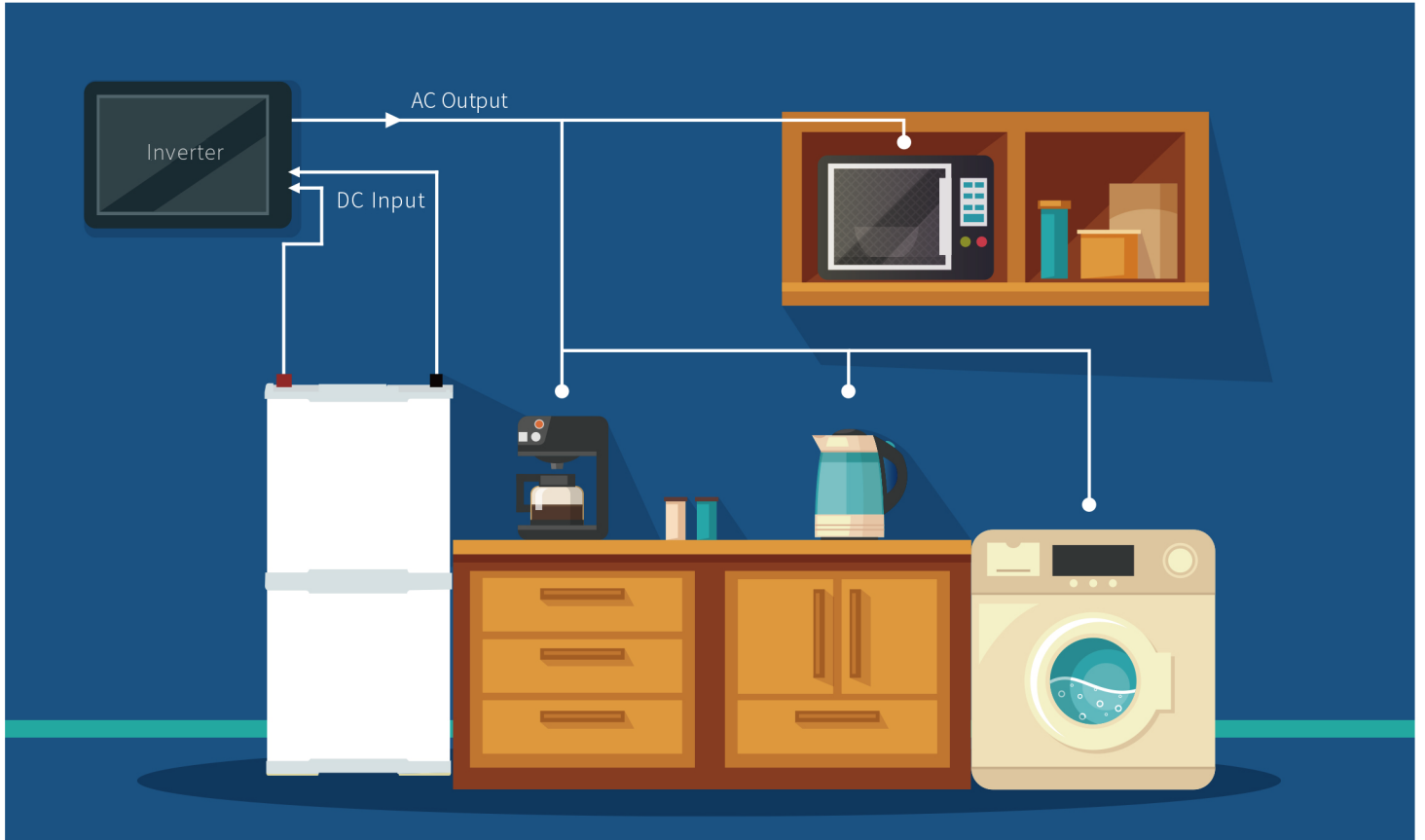



## BCT

### APPLICATION CASE



**10kWh**  
New Zealand

**System Configuration**

- Solar Panel
- Inverter
- 10kWh Energy Storage Battery



**20kWh**  
Shandong, China

**System Configuration**

- Solar Panel
- Inverter
- 20kWh Energy Storage Battery



**10kWh**  
Beijing, China

**System Configuration**

- Solar Panel
- Inverter
- 10kWh Energy Storage Battery



**10kWh**  
Nigeria

**System Configuration**

- Solar Panel
- Inverter
- 10kWh Energy Storage Battery